

# seca 878

## Instructions for Use

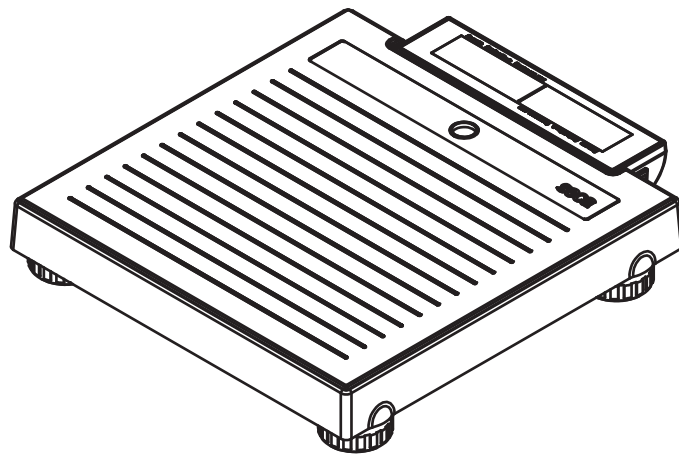

## CONTENTS

<b>1. Device description</b> .....	<b>3</b>	<b>5. Operation</b> .....	<b>11</b>
1.1 Intended use .....	3	5.1 Weighing .....	11
1.2 Description of function .....	3	Starting the weighing procedure .....	11
1.3 User qualification .....	3	Weighing babies/toddlers (2-in-1) .....	11
<b>2. Safety precautions</b> .....	<b>3</b>	Display measuring result permanently (HOLD) .....	12
2.1 Safety precautions in these instructions for use .....	3	Switching off the scale .....	12
2.2 Basic safety instructions .....	4	<b>6. Hygiene treatment</b> .....	<b>12</b>
Handling the device .....	4	6.1 Cleaning .....	13
Preventing electric shock .....	4	6.2 Disinfecting .....	13
Preventing injuries and infections .....	4	6.3 Sterilizing .....	13
Preventing device damage .....	5	<b>7. Function check</b> .....	<b>13</b>
Using the measured results .....	6	<b>8. What do I do if...?</b> .....	<b>14</b>
Dealing with packaging .....	6	<b>9. Maintenance/Verification</b> .....	<b>14</b>
2.3 Handling batteries and battery packs .....	7	<b>10. Technical data</b> .....	<b>15</b>
<b>3. Overview</b> .....	<b>8</b>	10.1 General technical data .....	15
3.1 Controls .....	8	10.2 Weighing technology data .....	15
3.2 Symbols in the display .....	8	<b>11. Optional accessories</b> .....	<b>16</b>
3.3 Marking on device and on the rating plate .....	9	<b>12. Disposal</b> .....	<b>16</b>
3.4 Identification on the packaging .....	9	12.1 Device .....	16
<b>4. Before you really get started ...</b> .....	<b>10</b>	12.2 Batteries and battery packs .....	16
4.1 Scope of delivery .....	10	<b>13. Warranty</b> .....	<b>16</b>
4.2 Establishing power supply .....	10	<b>14. Declaration of conformity</b> .....	<b>16</b>
Inserting battery .....	10		
Connect the power supply unit (optional) ...	10		
4.3 Setting up and aligning scale .....	11		

## 1. DEVICE DESCRIPTION

### 1.1 Intended use

---

The electronic personal scale is mainly used at hospitals, practices and inpatient care facilities in accordance with national regulations.

The scale is for conventional determination of weight and establishment of general state of nutrition; it assists the physician supervising treatment in making a diagnosis or deciding on a course of treatment.

To make an accurate diagnosis, however, other specific examinations have to be ordered by the physician and their results taken into account, in addition to determining a weight value.

### 1.2 Description of function

---

On the **seca 878** electronic personal scale, weight is detected by four load cells.

The **2 in 1** function can be used to determine the weight of babies and toddlers. The child is held in an adult's arms during weighing to do so.

### 1.3 User qualification

---

The device may only be operated by healthcare professionals.

## 2. SAFETY PRECAUTIONS

### 2.1 Safety precautions in these instructions for use

---

**DANGER!**

Used to identify an extremely hazardous situation. If you fail to take note of this information, serious irreversible or fatal injuries will occur.

**WARNING!**

Used to identify an extremely hazardous situation. If you fail to take note of this information, serious irreversible or fatal injuries may result.

**CAUTION!**

Used to identify a hazardous situation. If you fail to take note of this information, minor to moderate injuries may result.

**NOTICE!**

Used to identify possible incorrect usage of the device. If you fail to take note of this information, you may damage the device, or the measuring results may be incorrect.

**NOTE**

Includes additional information about use of the device.

## 2.2 Basic safety instructions

---

### Handling the device

- ▶ Please take note of the information in these instructions for use.
- ▶ Keep the instructions for use in a safe place. The instructions for use are a component of the device and must be available at all times.



#### **DANGER!**

##### **Risk of explosion**

Do not use the device in an environment in which one of the following gases has accumulated:

- oxygen
- flammable anesthetics
- other flammable substances/air mixtures



#### **CAUTION!**

##### **Patient hazard, damage to device**

- ▶ Have servicing and verification carried out regularly as described in the relevant section of this document.
- ▶ Technical modifications may not be made to the device. The device does not contain any parts for servicing by the user. Only have servicing and repairs performed by an authorized seca Service partner. You can find service partners in your area at [www.seca.com](http://www.seca.com) or by sending an e-mail to [service@seca.com](mailto:service@seca.com).
- ▶ Only use original seca accessories and spare parts, otherwise seca will not grant any warranty.



#### **CAUTION!**

##### **Patient hazard, malfunction**

- ▶ Keep other electrical medical devices, e.g. high-frequency surgical devices, a minimum distance of approx. 1 meter away to prevent incorrect measurements or wireless transmission interference.
- ▶ Keep HF devices such as cell phones a minimum distance of approx. 1 meter away to prevent incorrect measurements or wireless transmission interference.
- ▶ The actual transmission output of HF equipment may require minimum distances of more than 1 meter. Details can be found at [www.seca.com](http://www.seca.com).

### Preventing electric shock



#### **WARNING!**

##### **Electric shock**

- ▶ Set up the device so that the power supply socket is easy to reach and the device can be disconnected from the power supply quickly.
- ▶ Ensure that your local power supply matches the information on the power supply unit.
- ▶ Do not touch the power supply unit with wet hands.
- ▶ Do not use extension cables or power strips.
- ▶ Make sure that cables are not pinched or damaged by sharp edges.
- ▶ Make sure that cables do not come into contact with hot objects.
- ▶ Do not operate the device at an altitude of more than 3000 m above sea level.

### Preventing injuries and infections



#### **WARNING!**

##### **Injury from falls**

- ▶ Ensure that the device is positioned firmly and level.
- ▶ Route connecting cables (if present) in such a way that neither user nor patient can trip over them.

- ▶ The device is not designed as a standing aid. Assist people with limited motor skills when they are getting up, e.g. from a wheelchair.
- ▶ Make sure that the patient does not step onto and off the weighing platform right at the edges.
- ▶ Make sure that the patient steps onto and off the weighing platform slowly and safely.

**WARNING!****Danger of slipping**

- ▶ Ensure that the weighing platform is dry before the patient steps onto it.
- ▶ Ensure that the patients feet are dry before he or she steps onto the weighing platform.
- ▶ Make sure that the patient steps onto and off the weighing platform slowly and safely.

**WARNING!****Risk of infection**

- ▶ Before and after every measurement, wash your hands to reduce the risk of cross-contamination and nosocomial infections.
- ▶ Hygienically reprocess the device regularly as described in the respective section in this document.
- ▶ Make sure that the patient has no infectious diseases.
- ▶ Make sure that the patient has no open wounds or infectious skin alterations, which may come into contact with the device.

**Preventing device damage****NOTICE!****Damage to device**

- ▶ Ensure that no liquids enter the device. They can damage the electronics.
- ▶ Switch off the device before disconnecting the power supply unit from the mains socket.
- ▶ For devices with power supply operation: Disconnect the power supply unit from the mains socket if you intend to not use the device for a longer period of time. Only this way it can be ensured that the device is de-energized.
- ▶ For devices with battery or rechargeable battery operation: If you do not use the device for an extended period of time, remove batteries or rechargeable batteries. Only this way it can be ensured that the device is de-energized.
- ▶ Make sure not to drop the device.
- ▶ Do not expose the device to any impacts or vibrations.
- ▶ Perform function controls regularly as described in the relevant section in this document. Do not operate the device if it is damaged or not working properly.
- ▶ Ensure that there is no heat source in the immediate vicinity. Do not expose to direct sunlight. The excessive temperature could damage the electronics.
- ▶ Avoid rapid temperature fluctuations. When the device is transported so that a temperature difference of more than 20 °C occurs, it must stay turned off for at least 2 hours before it can be turned on again. Otherwise, condensation water will form which can damage the electronics.
- ▶ Use the device only in intended ambient conditions.
- ▶ Store the device only in the intended storage conditions.
- ▶ Use only chlorine and alcohol-free disinfectants which are explicitly suitable for acrylic sheet and other sensitive surfaces (active ingredient: quaternary ammonium compounds, for example).

- ▶ Do not use aggressive or abrasive cleaning agents.
- ▶ Do not use organic solvents (e.g. white spirit or petroleum spirit).

## Using the measured results



### **WARNING!** **Patient hazard**

This device is **no** diagnostic device. It simply assists the treating physician in establishing a diagnosis.

- ▶ In order to make a precise diagnosis and initiate therapeutic measures, besides determination of the weight, further targeted examinations must be set up by the physician, and their results must be considered.
- ▶ The responsibility for diagnosis and treatment lies with the treating physician.

### **NOTICE!**

#### **Inconsistent measuring results**

- ▶ Before you electronically save measured values determined using this device and use them further (e.g. in seca PC software or in a hospital information system), make sure that the measured values are plausible.
- ▶ If measured values are transmitted to seca PC software or a hospital information system, make sure prior to further use that the measured values are plausible and are assigned to the correct patient.

## Dealing with packaging



### **WARNING!** **Risk of suffocation**

Packaging material made of plastic foil (bags) is a choking hazard.

- ▶ Keep packaging material out of reach of children.
- ▶ In the event that the original packing material may not be available anymore, only use plastic bags with security holes in order to reduce the risk of suffocation. Use recyclable materials if possible.

### **NOTE**

Keep the original packing material for future use (e.g. returning for servicing).

## 2.3 Handling batteries and battery packs

---

seca devices are supplied with a rechargeable battery pack or with batteries depending on model. Heed the following safety instructions.



### **WARNING!**

#### **Personal injury as a result of improper handling**

Batteries and rechargeable batteries contain harmful substances which may explode if not handled properly.

- ▶ Do not try to recharge batteries.
- ▶ Do not expose (rechargeable) batteries to heat.
- ▶ Do not burn (rechargeable) batteries.
- ▶ If acid is leaking out, avoid contact with the skin, eyes and mucous membranes. Rinse affected areas with plenty of clean water and seek medical help at once.

### **NOTICE!**

#### **Damage to device and malfunctions with improper handling**

- ▶ Only use the type of (rechargeable) battery specified in this document.
- ▶ When replacing (rechargeable) batteries, always replace a complete set at a time.
- ▶ Do not short-circuit (rechargeable) batteries.
- ▶ If you do not use the device for a long period of time, remove the batteries (incl. rechargeable batteries). This prevents acid from leaking into the device.
- ▶ If acid leaked into the device, discontinue use. Have the device checked by an authorised seca Service partner and repaired if necessary.

### 3. OVERVIEW

#### 3.1 Controls

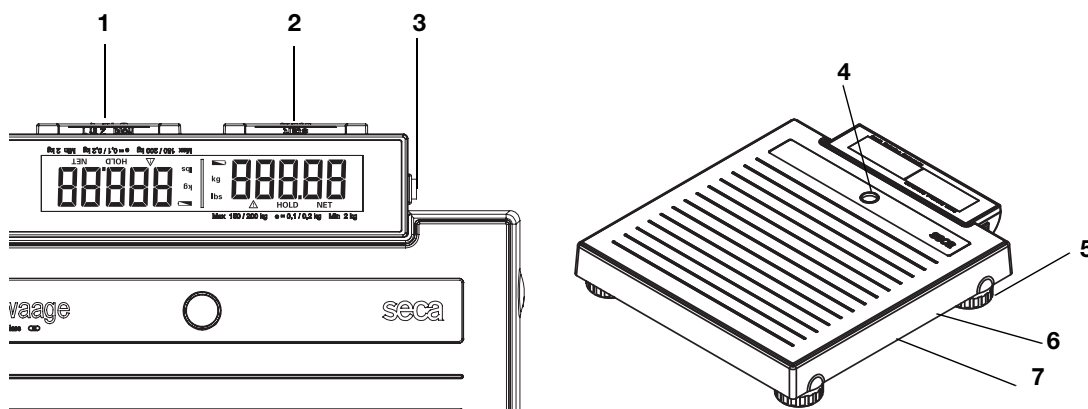

No.	Control	Function
1	hold/ 2 in 1 key	<ul style="list-style-type: none"> <li>Activating the <b>hold</b> function</li> <li>Starting the <b>2 in 1</b> function to weigh babies and toddlers</li> </ul>
2	start key	Starting the weighing function
3	On/off switch	Switching the scale on and off
4	Spirit level	Shows whether the device is horizontal
5	Foot screw	4 pcs, for precise alignment
6	Power supply connection	For connecting a power supply unit available as an option
7	Battery compartment	Takes 6 AA-type batteries, 1.5 V



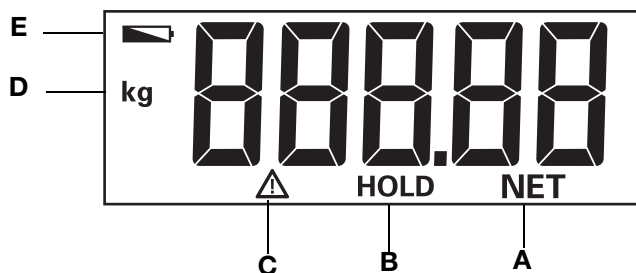







#### 3.2 Symbols in the display







	Symbol	Meaning
A	NET	Tare function active
B	HOLD	Hold function active
C	△	Non-verifiable function active
D	kg / g	Weight value in kilograms/grams
E	🔋	Batteries are low



### 3.3 Marking on device and on the rating plate

Text/symbol	Meaning
	Name and address of manufacturer, date of manufacture
	Model number
	Serial number, consecutive
<b>GAL</b>	Value in m/s <sup>2</sup> (verified models) <ul style="list-style-type: none"> <li>• Gravitational acceleration on earth</li> <li>• Depends on the intended location</li> </ul>
<b>ProdID</b>	Product identification number, consecutive
<b>Approval Type</b>	Type designation of design approval
	Follow instructions for use
	Electrical medical device, type B
e	Value in mass units (verified models) <ul style="list-style-type: none"> <li>• Gives the difference between two consecutive display values</li> <li>• Used to classify and verify a scale</li> </ul>
→ ←	Weighing range (verified models)
	Device complies with EU standards and directives. <ul style="list-style-type: none"> <li>• <b>M</b>: Conformity label according to Directive 2014/31/EU governing non-automatic weighing instruments (verified models)</li> <li>• <b>18</b>: (Example: 2018) Year in which the declaration of conformity was completed and the CE symbol was applied (verified model)</li> <li>• <b>0102</b>: Notified body metrology (verified models)</li> <li>• <b>0123</b>: Notified body medical products</li> </ul>
	Class III scale to Directive 2014/31/EU and OIML R76-1
	Rating plate on the power supply connection socket <ul style="list-style-type: none"> <li>• <b>xx V</b>: required supply voltage</li> <li>• <b>max xx A</b>: maximum current consumption</li> <li>• : note polarity of device plug.</li> <li>• : operate device with direct current</li> </ul>
	Do not dispose of device with household waste

### 3.4 Identification on the packaging

	Protect from moisture
	Arrows indicate top of product. Transport and store in an upright position.
	Fragile Do not throw or drop.
	Permitted min. and max. temperature for transport and storage
	Permitted min. and max. moisture for transport and storage

↑↑	Open packaging here
♻️	Packaging material can be disposed of through recycling programs

## 4. BEFORE YOU REALLY GET STARTED ...

### 4.1 Scope of delivery

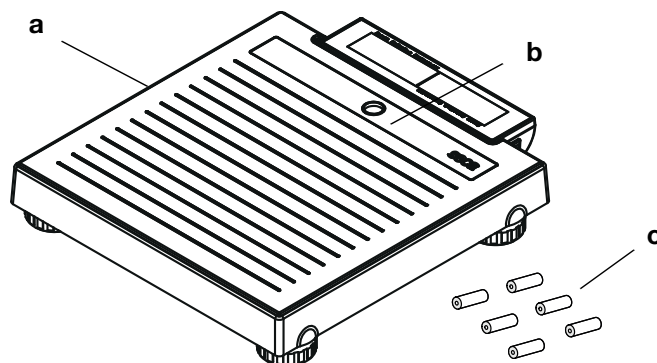

No.	Component	Pcs.
<b>a</b>	Personal scale	1
<b>b</b>	Interchangeable design panel	1
<b>c</b>	Battery	6
-	"Changing design panel" flyer	1
-	Operating instructions	1

### 4.2 Establishing power supply

#### Inserting battery

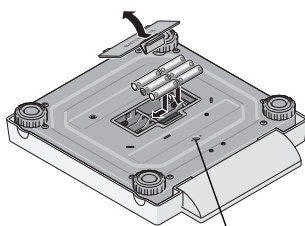

Connection for power supply unit

You need 6 AA-type batteries, 1.5 V (included in the scope of delivery).

1. Press on the latch of the battery compartment.
2. Remove the cover of the battery compartment.
3. Insert the batteries.

#### NOTE:

Ensure the correct polarity of the batteries (markings in the battery compartment). If the display **bAtE** appears, you have inserted one of the batteries the wrong way round or the batteries have discharged.

4. Close the battery compartment.

#### Connect the power supply unit (optional)

The scale can be operated with a power supply unit (accessory).



#### WARNING!

**Using the wrong power supply units may cause bodily injury or damage to the device**

Conventional power supply units may deliver a higher voltage than is indicated on them. The scale may overheat, catch fire, melt or short-circuit.

- ▶ Use only original seca plug-in power supply units with controlled 12 V output voltage.

1. Insert the plug required for your power supply into the power supply unit.

2. Insert the connector of the power supply unit into the connecting socket of the scale.
3. Plug the power supply unit into a power supply socket.

### 4.3 Setting up and aligning scale

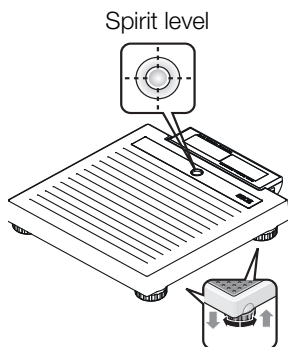

1. Place the scale on a firm surface.
2. Align the scale by turning the foot screws.  
The air bubble in the spirit level must be located in the exact center of the circle.
3. Ensure that only the feet of the scale are in contact with the ground. The scale may not be in contact anywhere else.

**NOTE:**

The alignment of the base of the scale must be checked every time the scale is moved and corrected if required.

## 5. OPERATION

### 5.1 Weighing

#### Starting the weighing procedure



1. Ensure that there is no load on the scale.
2. Press the **start** key.  
**SECA** appears in the display, then all the elements of the display are shown briefly.  
The scale is operational when **0.0** appears in the display.  
If the scale is operated with a power supply unit, the  $\psi$  symbol appears in the display.
3. Stand on the scale and keep still.
4. Read off the measured result.

#### Weighing babies/toddlers (2-in-1)

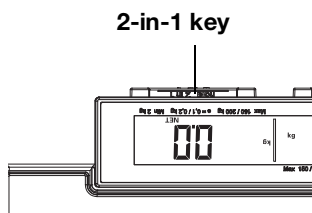

The **2 in 1** function can be used to determine the weight of babies and toddlers. The child is held in an adult's arms during weighing to do so. Proceed as outlined below.

1. Ensure that there is no load on the scale.
2. Ask the adult to stand on the scale.
3. Read off the measured result.
4. Keep the **2 in 1** key depressed until the message NET appears in the display.

The weight is saved.

**0.0** appears in the display.

**ATTENTION!**

**Incorrect measurement as a result of changing starting weight**

If weighing of the child commences with a different starting weight, it will not be possible to determine the child's weight correctly.

- ▶ Ensure that the child is always weighed with the adult with whom the starting weight was determined.
- ▶ Ensure that the adult's weight does not change - as a result of their taking off a piece of clothing, for example.

5. Ask the adult to get onto the scale holding the child.



The child's weight is displayed.

The  $\triangle$  symbol and the messages "HOLD" and "NET" are displayed.

6. Ask the adult to get off the scale with the child.
7. In order to deactivate the **2 in 1** function, press the **2 in 1** key until the  $\triangle$  symbol and the "HOLD" and "NET" messages are no longer displayed, or switch off the scale.

### Display measuring result permanently (HOLD)

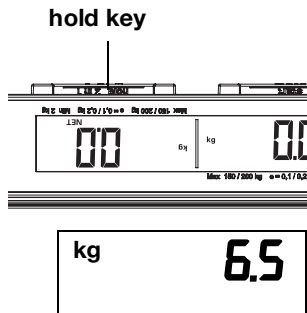

When you activate the HOLD function, the weight value continues to be displayed after the load is removed from the scale. This enables you to attend to the patient before recording the weight.

1. Ensure that there is no load on the scale.
2. Ask the patient to position him or herself on the scale.
3. Briefly press the **hold** key.

The display flashes until a stable weight is measured. The weight is then continuously displayed. The  $\triangle$  symbol (non-verifiable function) and the message "HOLD" are displayed.

4. To deactivate the HOLD function, press the **hold** key. The  $\triangle$  symbol and the "HOLD" message are no longer displayed.

### Switching off the scale

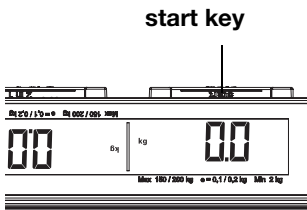

- ▶ Press the **start** key.

#### NOTE:

The scale switches off automatically after a short time if there is no load on it.

## 6. HYGIENE TREATMENT



#### WARNING!

##### Electric shock

The device is not de-energized when the on/off key is pressed and the display goes out. Use of fluids on the device may cause electric shock.

- ▶ Ensure that the device is switched off before performing any hygiene treatment.
- ▶ Disconnect the power supply connector before performing any hygiene treatment.
- ▶ Before each hygiene treatment, take the rechargeable battery out of the device (if present and removable).
- ▶ Ensure that no fluids penetrate the device.

#### NOTICE!

##### Damage to device

Inappropriate detergents and disinfectants may damage the sensitive surfaces of the device.

- ▶ Use only disinfectants free of chlorine and alcohol which are explicitly suitable for acrylic sheet and other sensitive surfaces (active ingredient: quaternary ammonium compounds, for example).
- ▶ Do not use caustic or abrasive detergents.
- ▶ Do not use organic solvents (e.g. white spirit or petroleum spirit).

## 6.1 Cleaning

---

- ▶ Use a soft cloth dampened with mild soapsuds to clean the surfaces of the device.

## 6.2 Disinfecting

---

1. Check that your disinfectant is suitable for sensitive surfaces and acrylic sheet.
2. Follow the instructions on the disinfectant.
3. Disinfect the device by moistening a soft cloth in disinfectant and wiping the device over with it.

Interval	Component
<b>Prior</b> to every measurement with direct skin contact	Weighing platform
<b>After</b> every measurement with direct skin contact	Weighing platform
If required	Display

## 6.3 Sterilizing

---

This device may not be sterilised.

## 7. FUNCTION CHECK

- ▶ Perform a function check prior to each use.

A complete function check includes:

- visual inspection for mechanical damage
- checking the alignment of the device
- visual and function check of the display elements
- function check of all the controls shown in the section entitled "Overview"
- function check of optional accessories

If you notice any faults or deviations during the function check, first try to resolve the error with the aid of the section entitled "What do I do if ..." in this document.



### **CAUTION!**

#### **Personal injury**

If you notice any faults or deviations during the function check which cannot be resolved with the aid of the section entitled "What do I do if ..." in this document, you may not use the device.

- ▶ Have the device repaired by seca Service or by an authorized service partner.
- ▶ Follow the section entitled "Servicing/verification" in this document.

## 8. WHAT DO I DO IF...?

Problem	Cause/solution
... no weight is displayed when there is a load on the scale?	The scale has no power supply. <ul style="list-style-type: none"> <li>- Check whether the scale is switched on</li> <li>- Check whether batteries are inserted</li> </ul>
... the scale switches on, during transport for example?	The <b>start</b> key has been pressed. As the scale has a very low energy consumption, this will have very little effect on battery life. <ul style="list-style-type: none"> <li>- Set the On/off switch to "OFF" for relatively long transport distances</li> </ul>
... a weight value appears in the display of the scale following transport or a change of batteries, even without a load on it?	The scale has determined an incorrect zero point. <ul style="list-style-type: none"> <li>- Start the scale again. The scale will then work normally again</li> </ul>
... 0.0 does not appear before weighing?	A load was already on the scale before it was switched on. <ul style="list-style-type: none"> <li>- Remove the load from the scale</li> <li>- Switch the scale off and back on again</li> </ul>
... - - - - appears before weighing instead of 0.0?	A load was already on the scale before it was switched on. <ul style="list-style-type: none"> <li>- Remove the load from the scale</li> <li>- Switch the scale off and back on again</li> </ul>
... one segment is illuminated either continuously or not at all?	The corresponding point has a fault. <ul style="list-style-type: none"> <li>- Inform the maintenance service</li> </ul>
... the display  appears?	Battery voltage is dropping. <ul style="list-style-type: none"> <li>- Insert new batteries as soon as possible</li> </ul>
... the display <b>bAtt</b> appears?	The batteries have discharged. <ul style="list-style-type: none"> <li>- Insert new batteries</li> </ul>
... the display <b>StOP</b> appears?	Maximum load has been exceeded. <ul style="list-style-type: none"> <li>- Remove the load from the scale</li> </ul>
... the display <b>Er</b> and a number appear?	The scale has been incorrectly loaded. <ul style="list-style-type: none"> <li>- Re-start the scale after it has switched off automatically. The scale will then work normally again.</li> <li>- If this is not the case, interrupt the power supply by switching the scale off briefly at the On/off switch. If this measure is also unsuccessful, inform the maintenance service.</li> </ul>

## 9. MAINTENANCE/VERIFICATION

We recommend having your device serviced prior to verification.



### CAUTION!

**Incorrect measurements as a result of poor servicing**

- ▶ Please only have servicing and repairs performed by an authorized service partner.
- ▶ You can find service partners in your area at [www.seca.com](http://www.seca.com) or by sending an e-mail to [service@seca.com](mailto:service@seca.com).

Have an authorized person perform verification according to national legal regulations.

Verification is always required if one or more verification seals are damaged.

## 10. TECHNICAL DATA

### 10.1 General technical data

General technical data	
Dimensions	
• Depth	360 mm
• Width	321 mm
• Height	60 mm
Net weight	approx. 4.0 kg
Temperature range	
• Operation	+10 °C to +40 °C (50 °F to 104 °F)
• Storage	-10 °C to +65 °C (14 °F to 149 °F)
• Transport	-10 °C to +65 °C (14 °F to 149 °F)
Air pressure	
• Operation	700 – 1060 hPa
• Storage	700 – 1060 hPa
• Transport	700 – 1060 hPa
Humidity	
• Operation	30 % – 80 %, no condensation
• Storage	0 % – 95 %, no condensation
• Transport	0 % – 95 %, no condensation
Height of digits	20 mm
Power supply	
• Power supply unit	
- Supply voltage	12 V
- Insulated device, protection class II (EN 60601-1)	<input type="checkbox"/>
• Batteries	
- Supply voltage	9 V
Maximum current consumption	typically 50 mA
Medical device in accordance with Directive 93/42/EEC	Class I with measuring function
EN 60601-1: electrical medical device, type B	
Type of protection	IP20
Operating mode	Continuous duty

### 10.2 Weighing technology data

Weighing technology data for seca 878	
Verification in accordance with Directive 2014/31/EU	Class III
Maximum load	200 kg
Minimum load	2 kg
Accuracy on initial verification	
• 0 to 50 kg	± 50 g
• 50 kg to 150 kg	± 100 g
• 150 kg to 200 kg	± 200 g
Graduations	
• 0 to 150 kg	100 g
• 150 kg to 200 kg	200 g

## 11. OPTIONAL ACCESSORIES

Accessory	Article number
Carry case <b>seca 421</b>	421-00-00-009
Carry case <b>seca 415</b>	415-00-00-009
Individualized design panel	01-13-05-499-009
Power supply: • Plug-in power supply, Euro: 230 V~ / 50 Hz / 12 V= / 150 mA • Switched-mode power supply unit: 100-240 V~ / 50-60 Hz / 12 V= / 0.5 A	68-32-10-252 68-32-10-266

## 12. DISPOSAL

### 12.1 Device



Do not dispose of the device with household waste. The device must be disposed of properly as electronic waste. Comply with the national provisions applicable in your country. For further information contact our service department at:

**service@seca.com**

### 12.2 Batteries and battery packs



Spent (rechargeable) batteries should not be discarded with household waste, regardless of whether they contain harmful substances or not. As a consumer you are obliged by law to dispose of (rechargeable) batteries via the collection points set up by the municipal authorities or the retail sector. Only discard (rechargeable) batteries when fully discharged.

## 13. WARRANTY

We offer a two-year warranty from the date of delivery for defects attributable to faulty material or poor workmanship. This excludes all moveable parts such as (rechargeable) batteries, cables, power supply units, etc. Defects which are covered by the warranty shall be rectified free of charge for customers on production of the sales receipt. No further claims can be accepted. The costs of shipment in both directions shall be borne by the customer where the device is not located at the customer's premises. In the event of any damage during shipment warranty claims can only be asserted where the complete original packaging was used for shipment and the scales were secured inside in the same manner as in the original packaging. You should therefore keep all packaging.

The warranty shall become null and void where the device is opened by persons not expressly authorised to do so by seca.

In the event of a warranty issue, please contact your local seca office or the dealer from whom you ordered the product.

## 14. DECLARATION OF CONFORMITY



seca gmbh & co. kg hereby declares that the product meets the terms of the applicable European directives. The unabridged declaration of conformity can be found at: [www.seca.com](http://www.seca.com).









# Medical Measuring Systems and Scales since 1840

seca gmbh & co. kg  
Hammer Steindamm 3–25  
22089 Hamburg · Germany  
T +49 40 20 00 00 0  
F +49 40 20 00 00 50  
E [info@seca.com](mailto:info@seca.com)

seca operates worldwide with headquarters  
in Germany and branches in:

[seca france](#)  
[seca united kingdom](#)  
[seca north america](#)  
[seca schweiz](#)  
[seca zhong guo](#)  
[seca nihon](#)  
[seca mexico](#)  
[seca austria](#)  
[seca polska](#)  
[seca middle east](#)  
[seca brasil](#)  
[seca suomi](#)  
[seca américa latina](#)  
[seca asia pacific](#)  
[seca danmark](#)  
[seca benelux](#)  
[seca lietuva](#)

and with exclusive partners in  
more than 110 countries.

All contact data at [seca.com](http://seca.com)